

Article number: 2314450506

Description: E+G polyamide wheel
RE.F8-80-RBL - loose wheel in polyamid

Measures

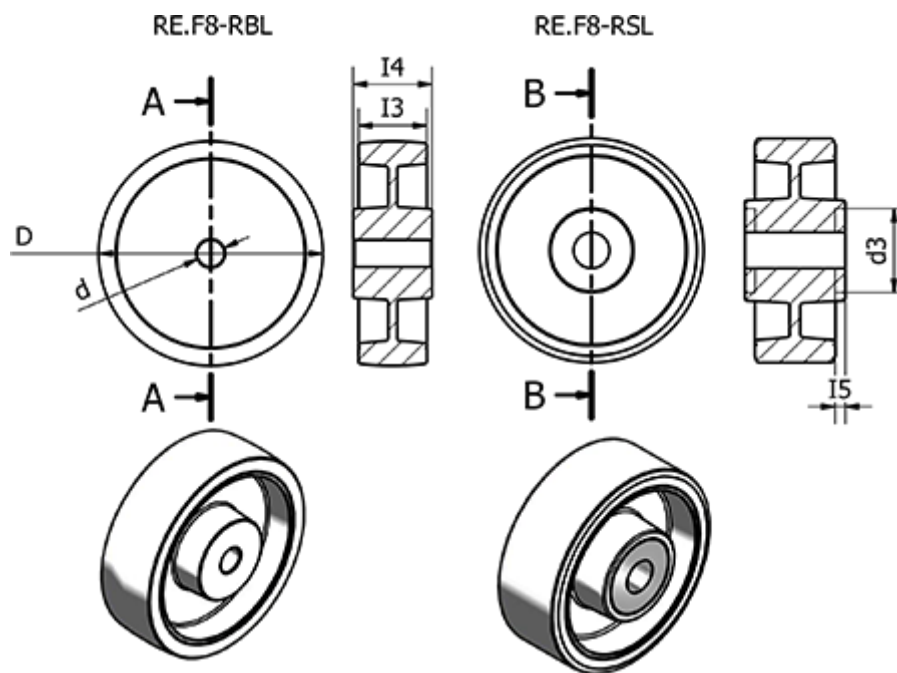

	= -	Rolling resistance (N) = 1500
Code	= 450506	Static load = 2000
d	= 80	Type = RE.F8-80-RBL
d3	=	Wight (g) = 80
Dynamic carrying capacity (N)	= 1800	
I3	= 30	
I4	= 39	
I5	=	